

USER MANUAL  
VRG14PL / VRG22PL  
**Desktop label finishing system**

WITH GRAPHTEC CE7000-40

THIS PRODUCT IS CERTIFIED:







**IMPORTANT:** Please keep the original packaging in case you need to return the material. If we receive the system in non-original packaging, the warranty will be void.



**IMPORTANT:** The latest version of the VIRGO software is available on our websites **[www.dpr-srl.it](http://www.dpr-srl.it)** or **[www.dpr-llc.com](http://www.dpr-llc.com)**, section "Download".

## SAFETY

---

The machine has to be installed in the specif place where only the autorised and trained technician can have the access.



**ATTENTION! Sharp cutter.**

Install the machine on a stable and robust table.

Ground connection mandatory, so please connect the machine to a power outlet with ground connection.

Only the plotter Graphtec CE7000-40 can be used on this machine.

## ELECTRONIC AND TECHNICAL DETAILS:

---

Input: 100-240V~ 2.0A, 50-60Hz

Power cord: 3 x 0.75 mm<sup>2</sup>

Fuse: T3.15 A 250 V

Working temperature: -10° / +40°

Working Humidity: 15-80%

*In Denmark: "Apparatets stikprop skal tilsluttes en stikkontakt med jord som giver forbindelse til stikproppens jord."*

*In Finland: "Laitte on liitettävä suojakoskettimilla varustettuun pistorasiaan"*

*In Norway: "Apparatet må tilkoples jordet stikkontakt"*

*In Sweden: "Apparaten skall anslutas till jordat uttag"*

# I N D E X

How to install the cutting plotter .....	page 3
System requirements .....	page 5
How to load and operate with the lamination module .....	page 6
How to adjust the clutch .....	page 8
How to load the laminated media into the plotter .....	page 8
How to run the cut test .....	page 9
How to load the matrix remover core holder .....	page 10
How to load the rewinder core holder and set the slitter module .....	page 11
How to add or remove blade holder .....	page 13
Metal guides alignment .....	page 13
Remove unwanted waste from the edge of the roll .....	page 13
Error Messages .....	page 14
Black-mark detection .....	page 14
Cutting file specifications .....	page 15
Black-mark position into the cutting file and printed artwork .....	page 16
Black-mark position in the media .....	page 16
How to cut blank labels .....	page 16
How to update software .....	page 17
How to restore plotter settings .....	page 17
When and how to reduce the plotter feeding speed .....	page 19
Media path .....	page 20
Tension arm calibration .....	page 20
Modules speed rotation .....	page 21
Graphtech mantenaice .....	page 22
How to replace the knife .....	page 24
How to replace the slitter blade .....	page 24
How to replace the cutting mat .....	page 25
Troubleshooting .....	page 26

# HOW TO INSTALL THE CUTTING PLOTTER

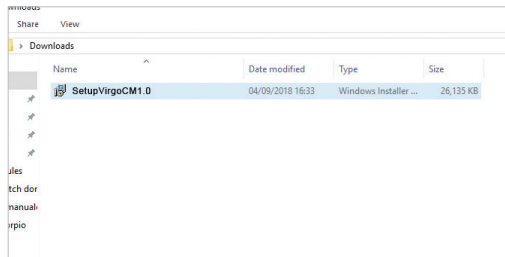

1. Click on “SetupVirgoCM...” and follow the step by step instructions to complete the installation.

**Please DO NOT connect the Virgo USB to your pc before the installation is complete**

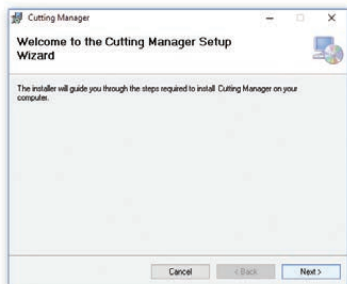

2. Click NEXT

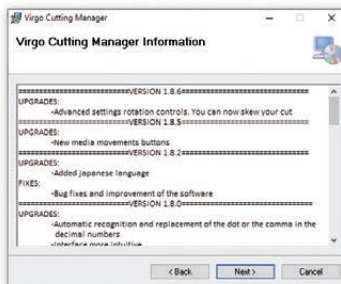

3. Click NEXT

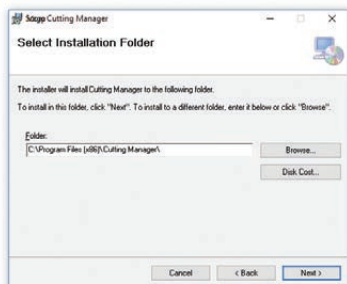

4. Click NEXT

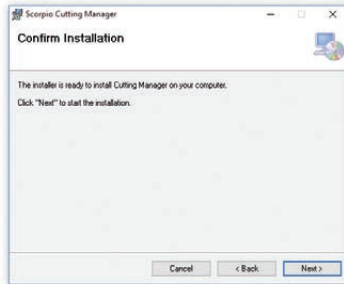

5. Click YES

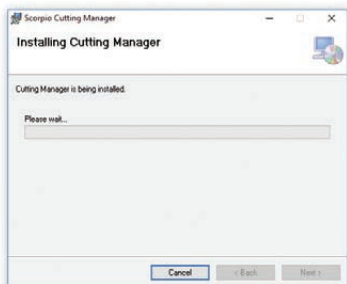

6. In process

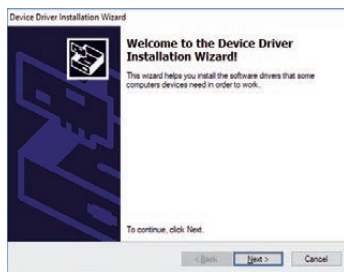

7. Click NEXT

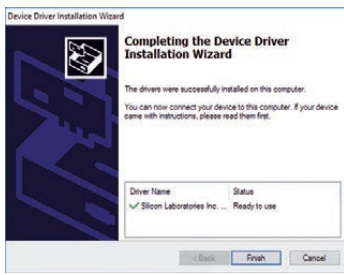

8. Click FINISH

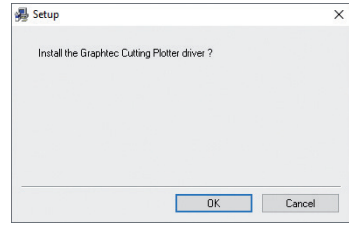

9. Click OK

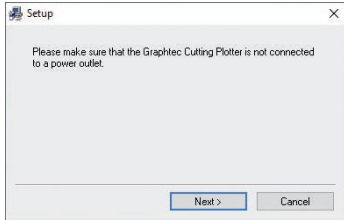

10. Click NEXT (*Remove the Virgo USB from your pc, and turn off the Virgo*)

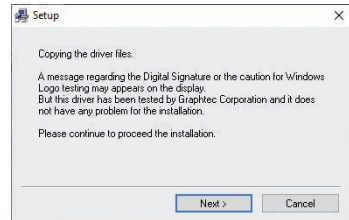

11. Click NEXT

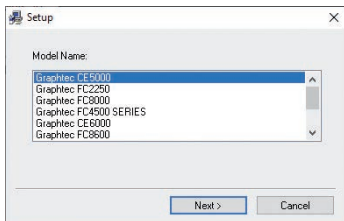

12. Choose the right model name of your Graphtec (**CE7000-40**).

Click NEXT



13. Wait until the sign “Update for the Graphtec CE7000-40 driver was completed” shows up. You may need to restart the computer.

Click OK

*The installation is completed. A VirgoCM shortcut is displayed on your desktop*

Plug in the USB camera and the USB dongle, they will auto-install.

**If your computer already has a camera installed, we recommend disabling it. If you do not, your pc will ignore the camera on the plotter.**

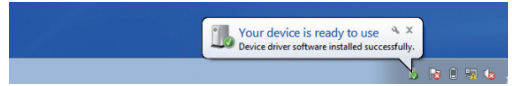
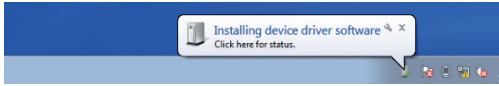

CM Software will generate a folder in the Windows start menu.

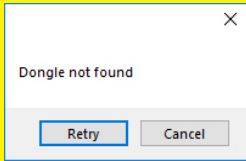

If the USB dongle is not installed correctly or is unplugged, the following error will appear.

## SYSTEM REQUIREMENTS

The Cutting Manager software works on Windows OS from Windows 8.1. We do not guarantee its functionality on previous versions. Not compatible with macOS systems.

Cutting files: Adobe Illustrator or and Corel Draw (save as PDF file).

Diagram connectors behind the on-off panel.

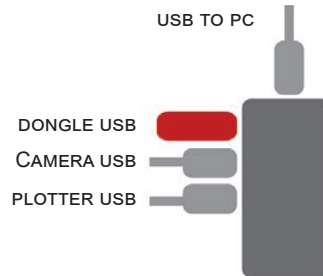



# HOW TO LOAD AND OPERATE THE LAMINATION MODULE

## MEDIA TENSION CONTROL

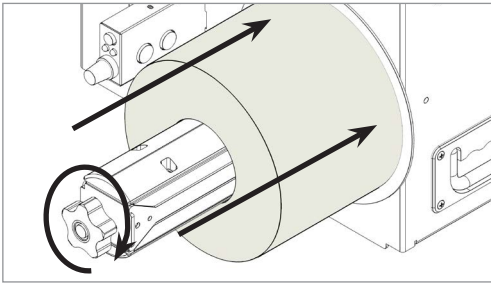
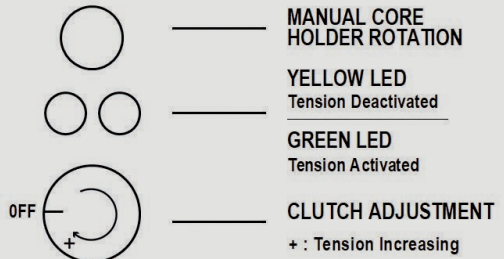
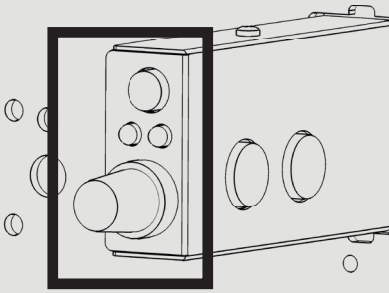

Load the printed roll against the disk.  
Tighten the core holder.

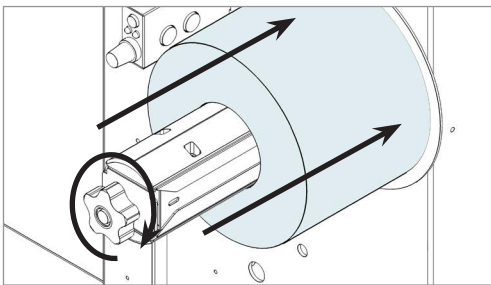

Load the lamination roll, move it along  
the supply shaft and make it match with  
the web, tighten the core holder.

**IMPORTANT:** the lamination roll always  
needs to be narrower than the web width.

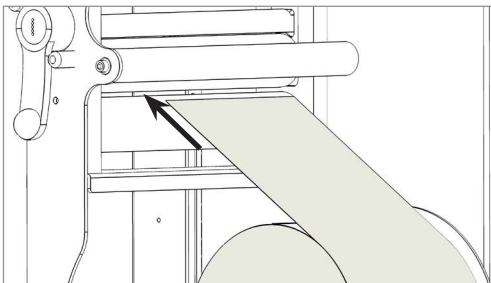

Load the media into the nip roller.

## WHEN TO ADJUST THE CLUTCH

It is important to keep the media and laminating film under tension using the clutch adjustments. If the tension is too tight, the roller system may be damaged; if the tension is too loose, the media will not be laminated properly.

## HOW TO LOAD THE LAMINATED MEDIA INTO THE PLOTTER

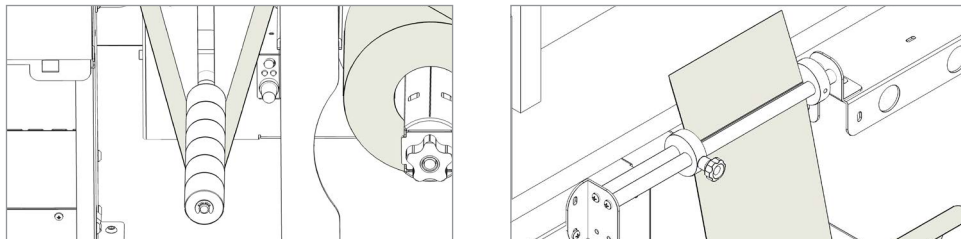

Pull the laminated media under the tension arm, then pass it between the aluminium rollers. The guide can be adjusted to prevent the media from shifting.

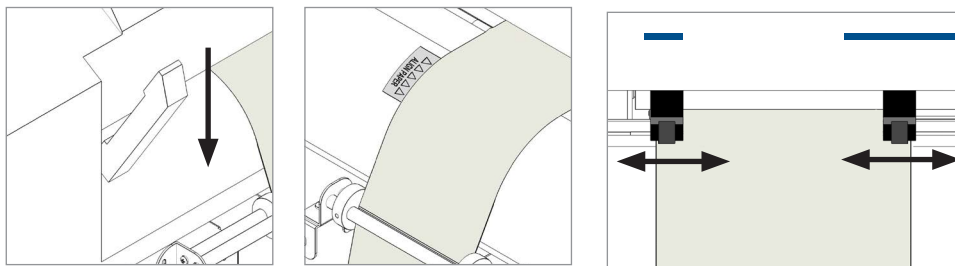

Put the lever, located in the rear of the plotter, in the down position.

Pull the media through the plotter, keeping the media edge in contact with the alignment points.

**Set both pinch rollers at the media edge.**

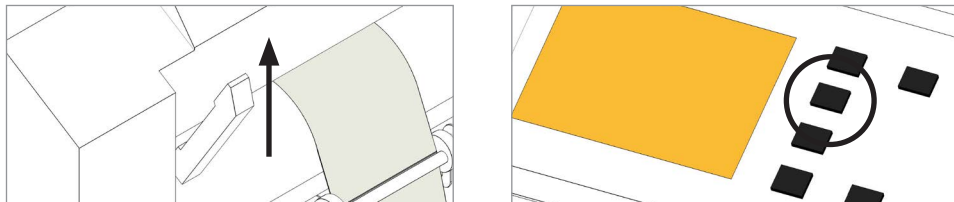

While holding the media in the aligned position with one hand, lift the handle on the rear of the plotter with the other to secure the media.

Press button 2 as requested on plotter's display.

## >> How to run the black-mark mode

User Interface at page 14 might be helpful.

1. Open Virgo Cutting Manager.
2. Press "OPEN PDF" or "OPEN LAST JOB" to load the Cut File.
3. Look at the camera preview, hold down "BACKWARD MEDIA" or "FORWARD MEDIA" arrows to move the web until the black-mark goes in the center position of the blue rectangle area.

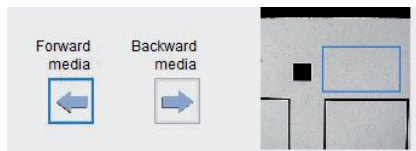

NO

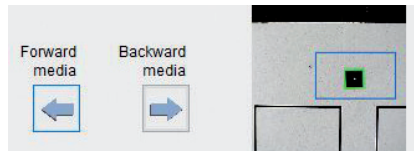

YES

4. Measure the distance in (MM) between the top of one black-mark to top of the next black-mark, key in this value in the "DISTANCE BETWEEN BLACKMARKS" box section.
5. Make sure the "Enable" in the blank mode is unflagged
6. Press "CUT TEST" to check for cut depth. If the liner has been cut, decrease the cutter pressure value in the cut force box. If label doesn't detach, increase the cutter pressure value in the cut force box.
7. Make sure label is aligned with the cut. **Through X and Y values in the software, adjust offsets if cut doesn't match label.**



MOVE DOWN  
THE CUTTING FILE

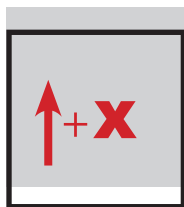

MOVE UP  
THE CUTTING FILE

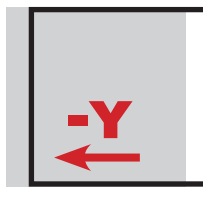

MOVE TO THE LEFT  
THE CUTTING FILE

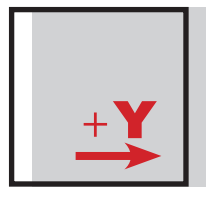

MOVE TO THE RIGHT  
THE CUTTING FILE

8. Once the cut settings are properly set, select "COPY MODE" ON if you desire a preset quantity of copies or OFF if to cut until the media roll is empty.
9. Set the black-mark size" in "BLACK-MARK MODE" area.
10. Press "START".



### **IMPORTANT:**

Whenever you lower and rise the lever while you are in black-mark mode, hold down the forward media arrow button to move again the plotter's head down

## >> How to run the blank mode

1. Press "OPEN PDF" or "OPEN LAST JOB" to load the cut file.
2. Set the copy mode **ON**, and set 2 as number of copies.
3. Click "START".
4. Check the horizontal position and the gap between the cuts.
5. If necessary, adjust the offset X and the distance between each cut in the "STEP" box.
6. Once the cut is set properly, select copy mode: ON if you desire a preset quantity of copies, or OFF to cut until the media roll is empty.
7. Click "START".

## HOW TO LOAD THE MATRIX REMOVER CORE HOLDER



**WARNING:** Before starting a job, always remove the waste media from the matrix remover core. Tape the matrix securely onto the cardboard core.

**System operating issues may occur if the above suggestions are not followed.**

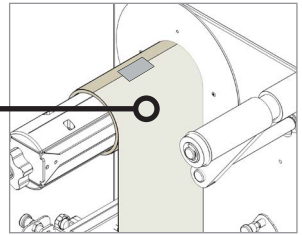
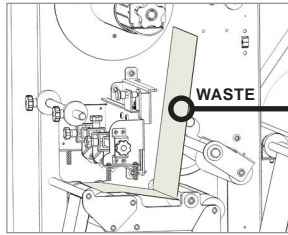
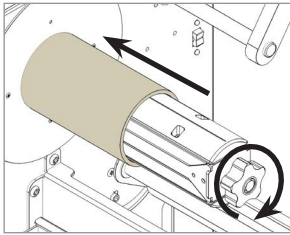

1. Load empty cardboard core(s) and tighten the core holder, then place the motorized core holder in position.
2. Peel back the matrix.
3. Pull the matrix and attach it to the matrix remover core holder.

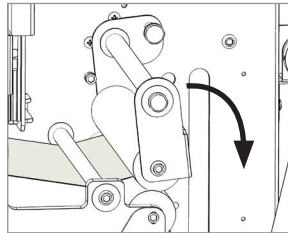
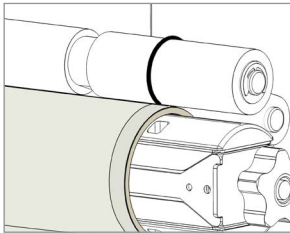

4. Pull down the waste press and relocate the o-rings to be over the waste matrix.
5. Close the sponge roller (not strong).

## HOW TO LOAD THE REWINDER CORE HOLDER AND SET THE SLITTER MODULE

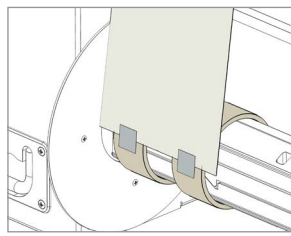
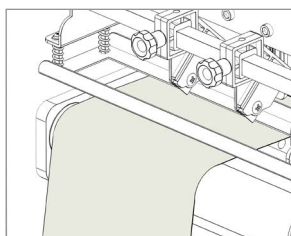
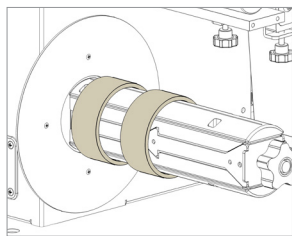

1. Load empty cardboard core(s) and tighten the core holder, then place the motorized core holder in position. Tighten the core holder.

**Cardboard core(s) should not be wider than the width of the finished roll.**

2. Pull the media through the aluminium rollers and attach the labels to the core using a waste label.

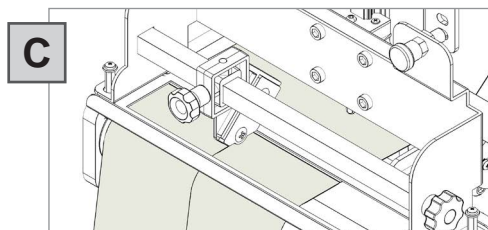
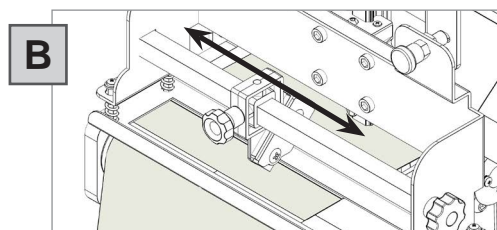
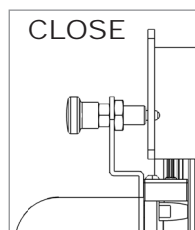
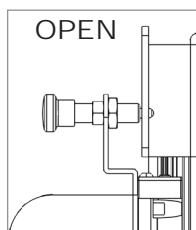
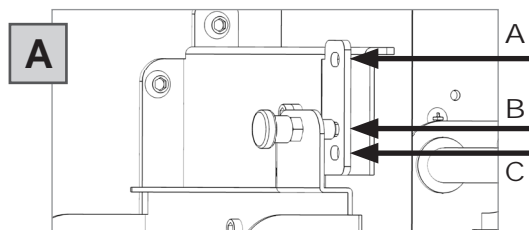

**Slitter module has 3 positions:**

- Upper position (A), the blades are lifted to allow the media loading;
- Middle position (B), align the blades with the edges and the center of the labels, tighten the thumb screw once the blade is in position;
- Lower position (C), the blade cut the media.

3. Turn ON the Matrix Remover module to rewind and start to slit the media, then turn OFF

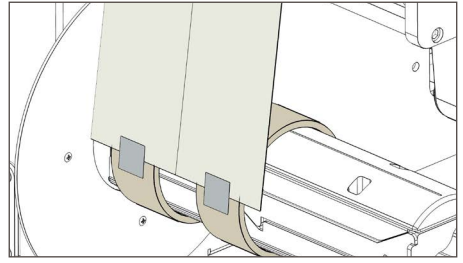
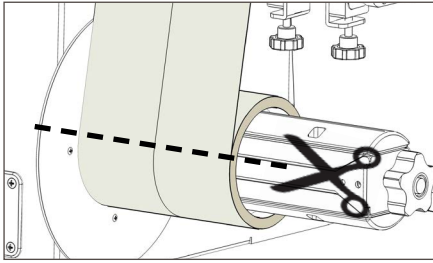

4. Cut the labels when the first “good” labels are visible.

5. Make sure the tension on all rolls is even, and attach each label to the core using a waste label or tape.

6. Turn the Matrix Remover module ON. **Press Resume to continue.**

## HOW TO ADD OR REMOVE A BLADE HOLDER

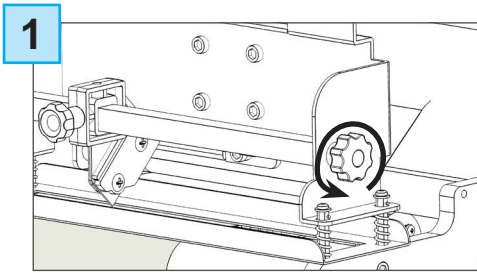

1 Remove the iron bar by unscrewing the black thumb screw.

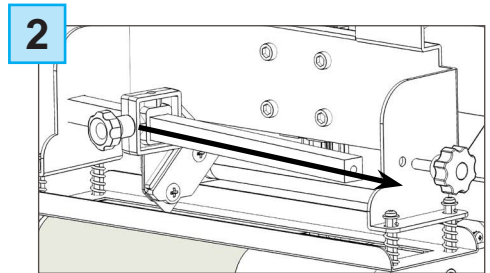

2 Slide the blade holder on or off. Replace the slide iron bar and rescrew the thumb screw.

## METAL GUIDES ALIGNMENT

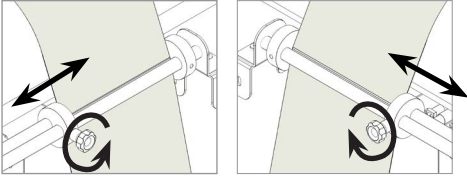

Media guides should be adjusted in order to prevent the web from shifting position.

## HOW TO CUT OUT THE EXTERNAL TRIMS

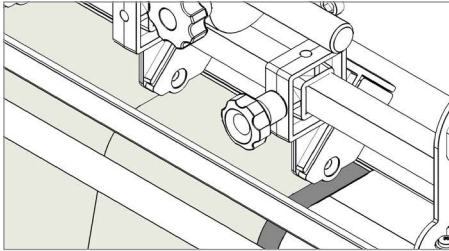

Position the blade holders according to the job requirements.

**IMPORTANT:** the external trims too thin may break, we recommend at least 4mm wide.

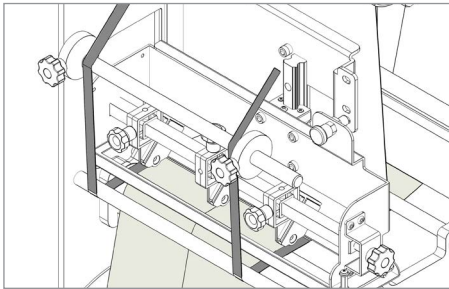

Pull up the trims keeping them behind the roller with guides.

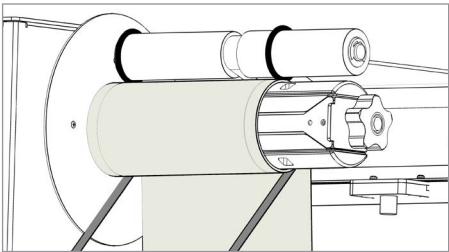

Attach the trims onto the waste removal core.

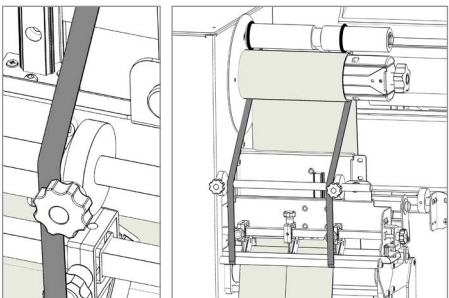

Move the guides to drive the rewinding trims on the desired position.

It is recommend to keep them inside the removed label area.

## ERROR MESSAGEGES

---

If the plotter is not correctly connected to the computer, the following errors will be displayed at application launch:

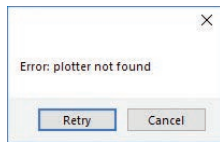

Make sure the plotter is switched on and properly connected. In case it is turned off, turn the plotter on and then press the button 2 on the control panel. Wait until the display shows "READY" as its status. Then, press retry on the popup window

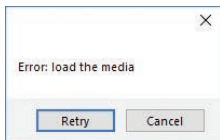

Ensure the media is loaded properly. Raise the lever on the plotter, then press the number 2 on control panel. Wait until the display shows "READY" as its status. Then, press retry on the popup window.

## BLACK-MARK DETECTION

---

It is important that the camera is reading the black mark properly.

Look at the camera preview, hold down "BACKWARD MEDIA" or "FORWARD MEDIA" arrows to move the web until the black-mark goes in the center position of the blue rectangle area.



WRONG POSITION



CORRECT POSITION

## CUTTING FILE SPECIFICATIONS

---

**Cut Files: Adobe Illustrator and/or Corel Draw (save as PDF file).**

The artwork file within the cutting shape must include a registration square black mark having a size of 4x4mm or 2x2mm.

**Only the cut contour lines (which must be completely vectorial and don't contain any filling) and black mark (not needed for the blank labels) can be in the saved cut file.**

Graphics layers must be deleted or the cut line shapes must be copied in a new file and saved instead of hiding or disabling any extra content.



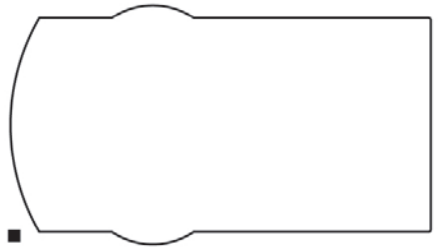

The cutting shape must be 100% black (otherwise in case of dashed lines, it must be a 100% magenta normal line) and have a thickness of 1 pt.

**The black-mark MUST ALWAYS be the object placed in the lower left corner of any layout file.**

*The Virgo Cutting Manager (VIRGO CM) work with the VECTOR PDF FILE. You can create this file with Adobe Illustrator or Corel Draw.*



**IMPORTANT:**

The Virgo Cutting Manager (VIRGO CM) works with VECTOR PDF FILE. You can create this file type with Adobe Illustrator or Corel Draw.



**IMPORTANT:**

To guarantee the black marks size and its position printed correctly on the media, the artwork must be printed with the actual size, make sure to avoid any fit or scale.

**BLACK-MARK POSITION INTO THE CUTTING FILE AND PRINTED ARTWORK**

Black-mark size: 4x4mm or 2x2mm

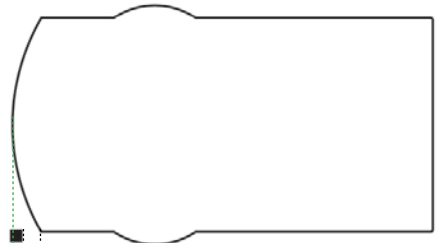
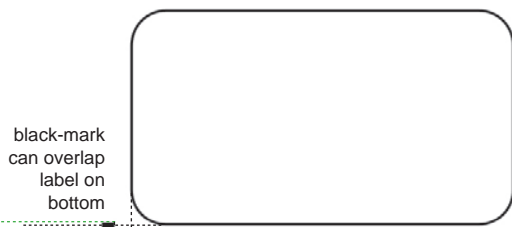

# BLACK-MARK POSITION IN THE MEDIA

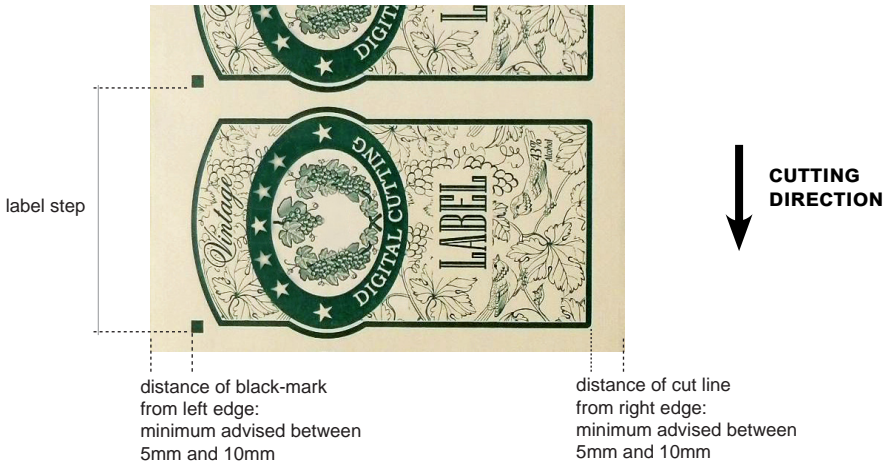

## HOW TO CUT BLANK LABELS

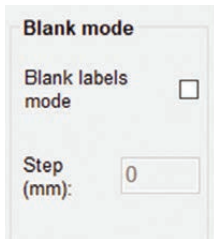

To use the “Blank Label Mode” feature to cut blank labels (without a registration mark), follow these steps:

1. Import the cut file (without a registration mark) into the software.
2. Select the “blank label” feature from the software and enter the number of copies that you wish to cut.
3. Click “Start”.

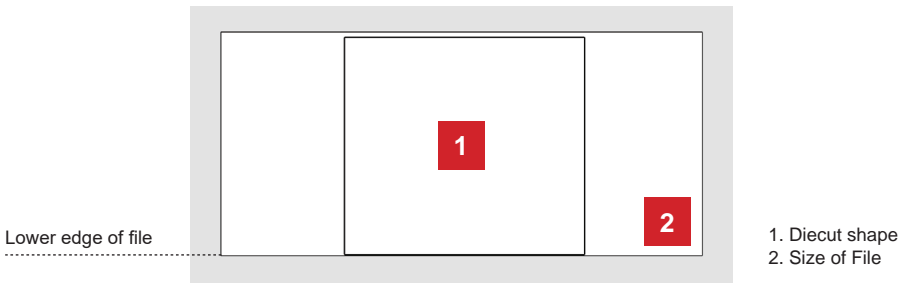

The diecut shape must be attached to the bottom edge of the file. The distance you leave will automatically be added to the gap that you will enter in the “STEP” box.



**WARNING:** Please note that enabling the blank label feature will disable both the cut test and Y offset adjustment.

## HOW TO UPDATE SOFTWARE

---

1. Go to Panel control.
2. Uninstall Virgo Cutting Manager.
3. Download from the website the new Cutting Manager release and run the installation.

## HOW TO RESTORE PLOTTER SETTINGS

---

1. Turn off the plotter.
2. Turn on the plotter while keeping pushed the UP arrow on the panel.

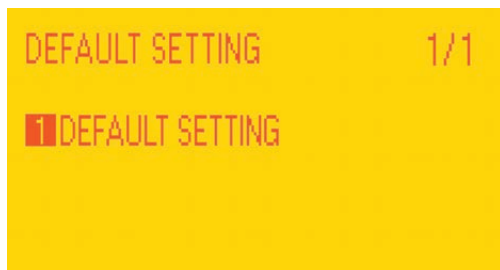
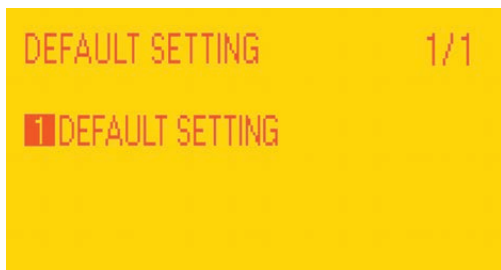

3. When the display shows “DEFAULT SETTING” press button 1.

4. Press button 1.

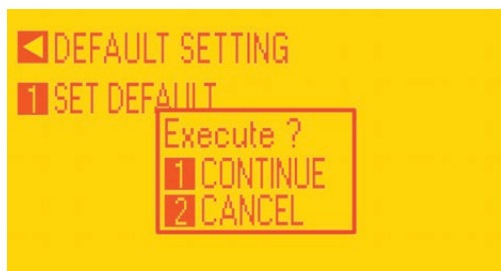

5. Press button 1.

6. In process.



7. When the display shows “SET DEFAULT COMPLETE” turn off the plotter.

8. Turn on the plotter and Choose the language and press enter.

## LENGTH UNIT

- 1 METRIC
- 2 INCH

9. Select metric by pressing button 1 and then enter.

## SELECT

- 1 ROLL-1 FRONT EDGE
- 2 ROLL-2 CURRENT POSITION
- 3 SHEET

10. Press button 2.

1: Condition no. 1  
CB09U+0 S30 F14 A2  
READY

- 1 VIEW
- 2 HOME

11. Wait until on the display appears "READY".



12. Press "PAUSE/MENU" then go to I/F (press up arrow key).

Esc INTERFACE 1/3  
▲  
1 BUFFER CLEAR  
2 COMMAND  
3 HP-GL ORIGIN POINT  
4 HP-GL MODEL EMULATED  
▼

13. Go to command (press 2).

## COMMAND

- 1 GP-GL
- 2 HP-GL
- 3 AUTO

ENTER SET CANCEL

14. Select GPGL (press 1 then enter).

1: Condition no. 1  
CB09U+0 S30 F14 A2  
READY

- 1 VIEW
- 2 HOME

15. Press "PAUSE/MENU".

## SELECT

- 1 ROLL-1 FRONT EDGE
- 2 ROLL-2 CURRENT POSITION
- 3 SHEET

16. Restart plotter then press button 2.



17. Wait until on the display appears “READY”.

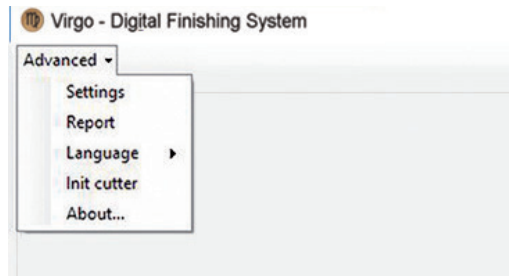

18. Open the Cutting manager and click on “Advanced” and then select “Init cutter”. Click “YES” to confirm



19. Wait until “Init cutter completed” will be shown in the status bar. Plotter display will show “LABEL MEDIA” as status.

## WHEN AND HOW TO REDUCE THE PLOTTER FEEDING SPEED

When cutting labels longer than 250mm, it is recommend to decrease the cutting speed. The amount of reduction depends on the job in process.

**The cutting speed can be set within the range of 50 to 600.**

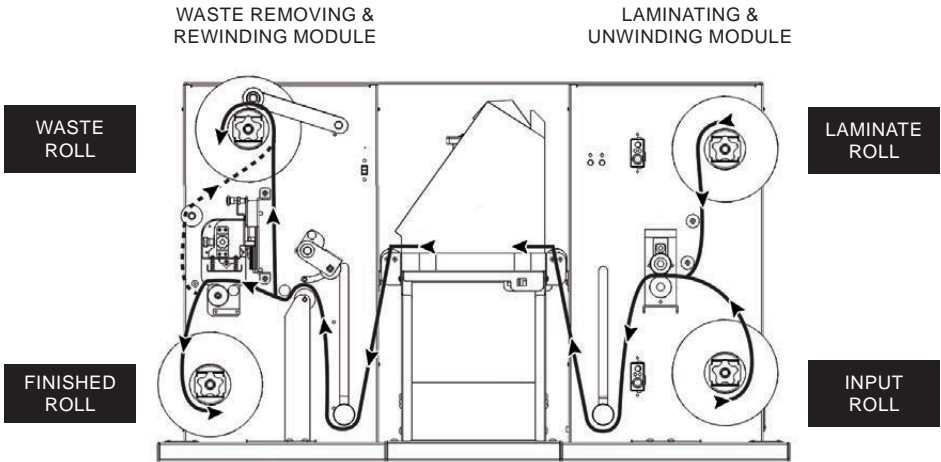

## TENSION ARM CALIBRATION (WASTE REMOVING & REWINDING MODULE)

Perform this procedure to set the unit to run properly with different labels length.

1. Turn OFF the module.
2. Using a paper clip, keep pushed the button into the small hole (above the Yellow Led) while switch ON the module. It beeps and the led turns on. Release the button.
3. Push again the button (the leds light up individually) until the desired option is selected:
  - Light up the Green Led to allow labels up to 250mm (9.84") long
  - Light up the Yellow Led to allow labels over 250mm (9.84") long
4. Turn off the unit to save the setting.
5. The tension arm has been set and ready to operate.



When the tension arm reaches the lowest position, both leds light up while the cores are still rotating.

After five seconds of this condition, both cores stop while the leds are blinking.

## LAMINATING & UNWINDING MODULE

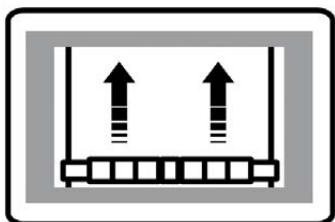

**SPEED  
INCREASE**

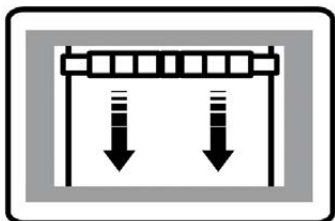

**SPEED  
DECREASE**

## WASTE REMOVING & REWINDING MODULE

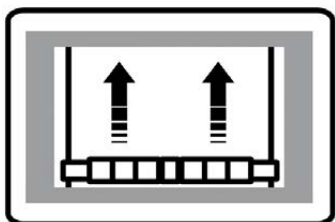

**SPEED  
DECREASE**

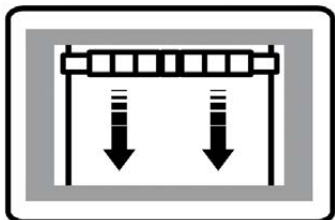

**SPEED  
INCREASE**

## Cutter Plunger

The plotter cuts using a cutter blade mounted in a plunger. There are two different plungers to suit the diameter of the cutter blade to be mounted (the 0.9 mm cutter plunger is provided as a standard accessory). Be sure to mount the cutter blade in the corresponding cutter plunger.

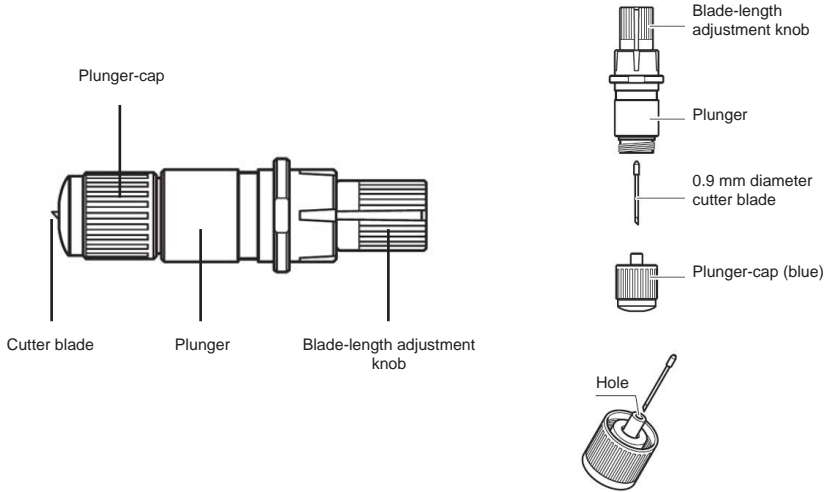

### **CAUTION:**

To avoid bodily injury, handle cutter blades with care.



**WARNING:** It may result in damaging the cutter blade or the cutting mat if the blade is extended too much. Make sure the blade length is set less than the thickness of the media.

Adjust the blade length by turning the blade-length adjustment knob. Turn the knob in direction “A” to extend the blade, or in direction “B” to retract the blade. When the knob is turned by one scale unit, the blade moves approximately 0.1 mm. One full turn of the knob moves the blade approximately 0.5 mm.

Cutter blade moves approximately 0.1 mm turning one scale unit

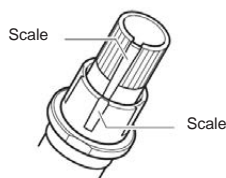
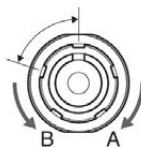



## **Mounting the tool**

1. Loosen the tool holder screw.

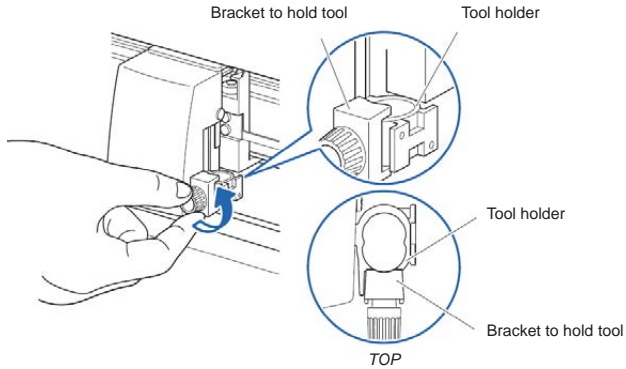

2. While pushing up the tool holder, push until its flange completely touches the upper part of the holder.

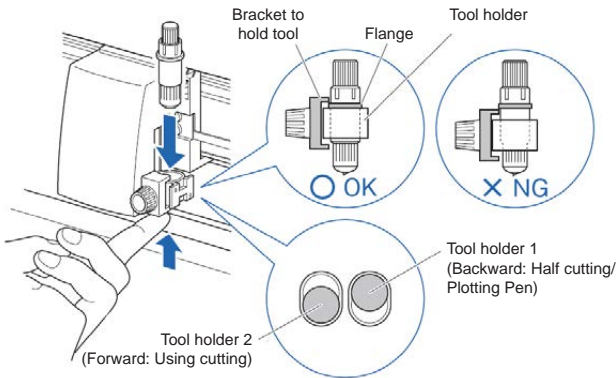

### **SUPPLEMENT:**

When using with half cutting and plotter pen, set the seal in Tool Holder 1 (backward), and when using cutting out (perforated cut), set the seal in Tool Holder 2 (forward).

3. Make sure that the tool bracket is engaged on the tool's flange, and then tighten the screw.

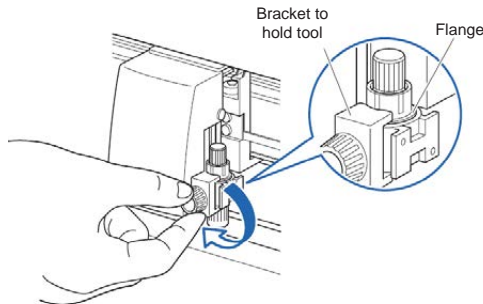

## **Removing the tool**

When removing the tool, turn it counterclockwise to remove the tool.

## HOW TO REPLACE THE KNIFE

See page 24 for the structure of the cutter plunger.

1. Turn the blade-length adjustment knob in the direction of the B arrow and pull the blade into the plunger.

Cutter blade moves approximately 0.1 mm turning one scale unit

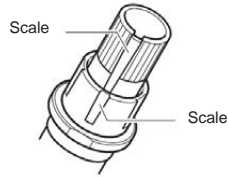
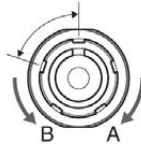

2. Turn the plunger cap in the counter-clockwise direction to remove it from the plunger.
3. Remove the blade from inside the plunger cap.
4. Remove a new blade from its pack. Insert the new blade into the hole provided in the plunger cap.
5. With the blade inserted into the plunger cap, screw on the plunger from above.
6. Fix the plunger cap by turning it clockwise.



**ATTENTION:** *In order to preserve the lifespan of the plotter knife and not to wear it out quickly, make sure to properly calibrate the knife exposure and cut force depending on the media thickness.*

## HOW TO REPLACE THE SLITTER BLADE

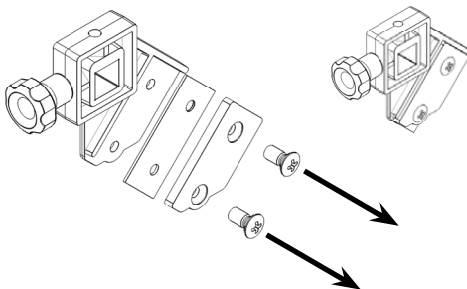

Remove the two screws holding the blade in place.

Replace the blade.

Replace the two screws holding the blade in place

# HOW TO REPLACE THE CUTTING MAT



## CAUTION:

**Please turn off the power when replacing the cutting mat.  
Please move the tool carriage to "A" position allowing  
for ease of work.**

### 1. Remove the cutting mat.

- The cutting mat is attached to the cutting base (fig.2)
- Please remove only the cutting mat from the cutting mat base from the location shown by the arrow (A) (fig.1)

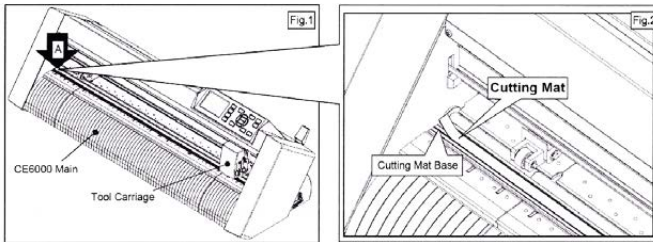

- After removing the cutting mat, please make sure that there is no adhesive tape or other adhesives left on the cutting base.
- Please clean the cutting mat base before installing the cutting mat.
- Installing the cutting mat with the remaining adhesive may affect cut quality.

### 2. Installing the cutting mat.

- Fit the cutting mat with the front cutting base grooves (fig.3) and attach it from the location shown by the arrow (A) (fig.1) while peeling off the release paper.

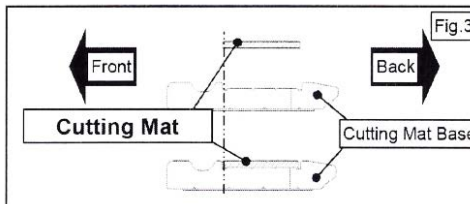

## IF YOU ARE EXPERIENCING THE FOLLOWING ISSUES WITH THE ANY OF OUR VIRGO UNITS, PLEASE FOLLOW TROUBLESHOOTING STEPS BELOW

---

### Yellow and Green LED's simultaneously on lamination control board (Applies to all Virgo models)

**Problem:** Yellow and Green LED's simultaneously on lamination control board. This will also create the following error:

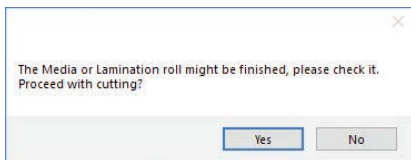

**Cause:** All Virgo Digital Finishing Systems are equipped with two reflective sensors on the lamination module. One is the media sensor, located right after the first two guide rollers, and the other is the lamination sensor, mounted between the two black knobs on the rubber roller assembly. When both the yellow and green LED's on lamination control panel are on, it would indicate that either one or both of the sensors have picked up an error and the cause could be due to either the media or lamination roll has run out or the sensors may be out of sync and needs to be re-calibrated. The following steps below will show you how to tell when each sensor is in error mode and how to correct it or help you re-calibrate each sensor if needed.

### Media not aligned properly

**Problem:** If the media is not aligned properly after running a couple of jobs.

**Cause:** This problem occurs for a couple of reasons. The primary reason would be that the tension force on the on the rubber roller assembly, media core and the lamination core (If using lamination) are all out of sync and needs adjusting. Another reason could be that the media was wounded unevenly to begin with thus creating an uneven media roll. Make sure the distance between top to top black-marks is set correctly.

**Fix:** First check to see if you have a flat even media roll before you begin installation. An uneven media roll will cause the job to misalign itself. If that checks out ok, then you will need to adjust the tension force on the lamination module. To do this you must turn the two black knobs located at the top the rubber roller assembly to adjust the tension force until you receive satisfactory results. If needed, this may have to be done in conjunction with adjusting the clutch tension on both the lamination core (*If using lamination*) and the material core using the aluminum handles. Adjust the tension force at all three locations accordingly until you get the perfect setting and the media is properly aligned.

## Plotter error “E01017 Hardware X Position Alarm Power off then on”

**Problem:** The plotter displays an error “E01017 Hardware X Position Alarm Power off then on”.

**Cause:** The plotter will give you this error after starting a job in *Virgo CM* and the tensioner arm was not set-up to begin with or the tensioner arm was positioned too high after turning on the lamination module.

**(\*\*NOTE\*\* To set the tensioner arm properly, the arm must always be at a midpoint position or lower before turning on the lamination module).**

### **Fix:**

1. To set-up the tensioner arm, first turn off lamination module.  
**(\*\*NOTE\*\* The lamination module must be off for the next steps to work.)**
2. Use the arrow buttons at the top of the control panel to manually feed the media forward until the arm descends into the correct position (**\*\*Correct position for the tensioner arm will be midpoint or lower\*\***).
3. Once Tensioner is in the correct position, turn ON lamination module.  
**(If done successfully, the tensioner arm will automatically re-adjust itself thus activating the unwinder motor).**
4. Restart Cutting Manager software

## Plotter is not cutting or Plotter cutting all the way through the material

**Problem:** After starting a job, you notice that the plotter is not producing a clean cut through the media or the plotter is cutting all the way through the media.

**Cause:** This happens if cut force in or blade exposure may be set too low if it's not producing a clean cut or if it's cutting all the way through the media it could be set too high.

**Fix:** If the plotter is not producing a clean cut, this can be fixed by either; increasing the cut force in *Virgo CM* while decreasing the blade exposure until the unit provides satisfactory results or you can also decrease the cut force and increase the blade exposure until it produces a perfect cut. Adjust both accordingly until the correct cut setting has been achieved.

If the plotter is cutting through the media, this can be fixed by decreasing both the cut force and blade exposure to factory settings and start by increasing the cut force until you get a clean cut. You may have to increase the blade exposure while decreasing the cut force there's a clean cut and the correct settings is has been achieved.

**(\*\*NOTE\*\*You can continue to increase the blade exposure if necessary, but remember that when you increase the blade exposure, do not simultaneously increase the cut force or you will cut through the cutting mat below the media. It is always best to increase one setting while decreasing the other or just increasing one setting only, normally the blade. Never increase both settings simultaneously)**

### **Plotter error “E01019 Hardware Y Position Alarm Power off then on”**



**Problem:** The plotter displays an error “E01019 Hardware Y Position Alarm Power off then on”.

**Cause:** This error occurs when the blade tray was moved from side to side by the user after loading the media onto the plotter and with the rear plotter lever in the up position.

**Fix:** To fix this error, you must first power off the plotter, turn the plotter back on, wait for the display on the plotter to load, then press the number “2” as instructed on the plotter to complete the set-up.

### **Plotter error “E05004 Hardware Realign Push Rollers Confirm”**



**Problem:** The plotter displays an error “E05004 Hardware Realign Push Rollers Confirm”

**Cause:** This error occurs when the pinch rollers are not aligned properly with the plotter’s grips.

**Fix:** Before feeding the material through the plotter (While the rear lever is in the down position) be sure that the pinch rollers are aligned properly with the plotter’s grips.

### **Cutting Manager error “Black-mark not found”**

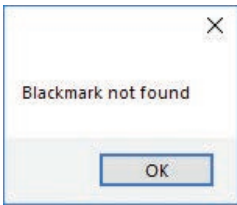

**Problem:** After starting a job in *Virgo CM*, you get an error “Black-mark not found”.

**Cause:** This problem occurs when after you start the job and the software can’t detect the black-mark on the media. The reason for this could be the following; the media is missing a marker to begin with; the media is not aligned with

the arrows points labeled on the front and back of the plotter; the plotter’s camera is not positioned correctly; and the plotter’s camera is picking up too much exposure from the sunlight or another light source.

**Fix:** To fix this, before you start any job in *Virgo CM* be sure to always do the following; check and make sure the media has a black-mark printed on it to begin with; manually aligned the media with the arrows points labeled on the front and back of the plotter (*This is done with the plotter’s rear handle in the down position*); make sure to position the plotter’s camera over the blackmark in order to centered marker as much as possible on the software camera preview.

**The Media or Lamination roll might be finished, please check it. Proceed with cutting?**

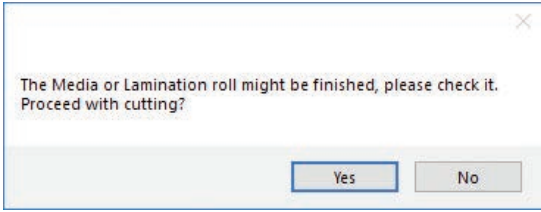

**Problem:** Yellow and Green light simultaneously on lamination control board.

**Cause:** When both the yellow and green LEDs on lamination control panel are on, it would indicate that either the media or lamination sensor have picked up an error or the sensors may be out of sync and need to be calibrated.

**Fix:** To fix this, please refer to the “Yellow and Green LED’s simultaneously on lamination control board” guide above to resolve.

**Error: load the media**

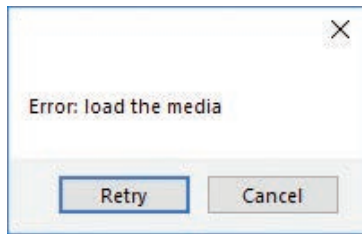

**Cause:** You launched the Cutting Manager while the plotter’s lever was down.

**Fix:** Rise the lever on the plotter, then press the button 2 on control panel and wait until the display will show “READY” as status. Then press retry on the popup window.

**Dongle not found**

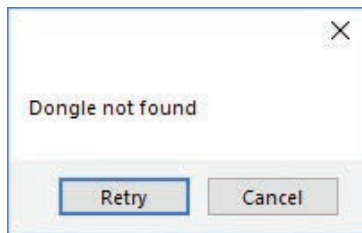

**Cause:** the software has been opened while the dongle (the red key) was not plugged to the internal hub or the virgo usb from the virgo was not plugged to the pc.

**Fix:** Plug the dongle to the hub, or the virgo usb to the pc and click retry.

### Can't load sensors

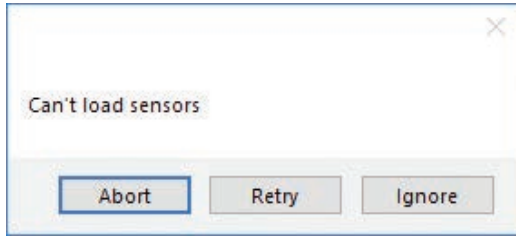

**Cause:** Media/Lamination sensors might be not plugged in correctly or turned off.

**Fix:** Check if sensors are powered up and plugged correctly into the black sensor box. Then Retry. If you do not want to keep activated the sensors, click Ignore.

### Error: plotter not found

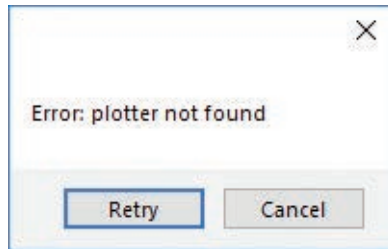

**Cause:** The plotter might be switched off or not properly connected.

**Fix:** Make sure the plotter is turned on and properly connected.

**In case it is turned off, please turn the plotter on and then press the button 2 on control panel and wait until the display will show "READY" as status. Then press retry on the popup window.**

### Last job not found

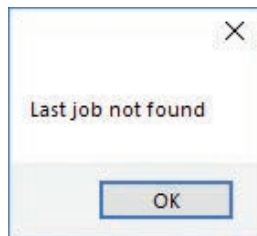

**Cause:** You will get this error when you try to open the last job when you run Cutting Manager for the first time after the installation.

**Fix:** Choose your file through "Open PDF".



**Please forward the media to the next black-mark**

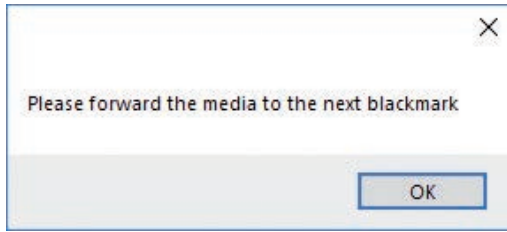

**Cause:** The starting Y position of the cut is a negative value (you can see coordinates on plotter's display when you move the media with arrows). **Keep in mind also the offset influences the starting position of the cut. So, if you start the cut at Y coordinates 0, while you have an offset Y value of -10, you will still get this error.** This error might happens when the media has been just loaded.

**Fix:** Move to the next black-mark. If it is not enough, forward until you have reached Y coordinate value major than 0.

**Please forward the media to reach a positive Y value shown on the plotter's display**

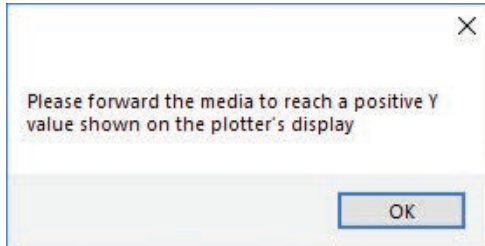

**Cause:** The starting Y position of the cut is a negative value (you can see coordinates on plotter's display when you move the media with arrows). This error might happens when the media has been just loaded.

**Fix:** Move forward until you have reached positive Y coordinates.

## Error after opening a .pdf file

- Cause:**
- The antivirus doesn't allow the software to open the file
  - The file is loaded from a server web or a remote disk. This may create issues sometimes
  - The file is not properly built

- Fix:**
- Add the cutting manager to your antivirus's whitelist
  - Move your file to your computer
  - The cutting file must contain only:
    - The contours lines
    - The Black-Mark, in case of Black-Mark mode cutting

## Processing the cut job had issues, or error after opening a .pdf file

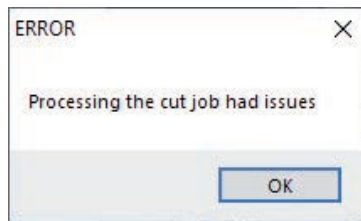

Make sure that:

- 1- The cut file contains **JUST VECTORIAL LINES AND NOT ANY FILLED FIGURE**, and has been built properly (*pag. 14*)
- 2- The cut file is opened from a pc folder, and not any usb or external network folder.
- 3- Add the cutting manager to your antivirus's whitelist.
- 4- Use just standard occidental letters or numbers for the file name.

## E02001 GPGL Error 1 command error!

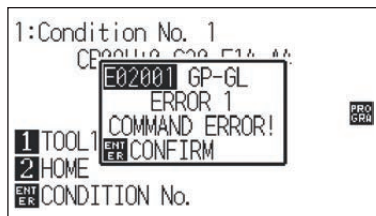

Make sure that:

- 1- The cut file contains JUST VECTORIAL LINES AND NOT ANY FILLED FIGURE, and has been built properly (*check pag. 14*)
- 2- The cut file is opened from a pc folder, and not any usb or external network folder

***If this doesn't solve, restore and init the plotter (pag.17-18)***

