

USER MANUAL

Label Rewinder
for EPSON C6500A



*Please keep the original packaging in case you need to return the unit.
If we receive the system in non-original packaging, the warranty may be void.*

The label rewriter specifically designed for Epson C6500A color label printer can handle rolls up to 220mm (8.66") media wide and having an outside diameter up to 250mm (10"). Unit is equipped with a fixed 3" core holder. An external power supply 100/240VAC - 2.5A $\overline{\text{---}}$ at 24V allows an electronic circuit to provide, through the tension arm, the speed and sense of rotation auto adjustment.

INSTALLATION

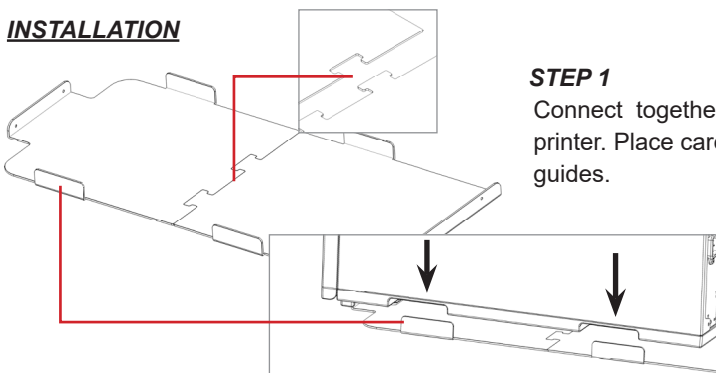

STEP 1

Connect together both plates and lean the printer. Place carefully the printer into the lock guides.

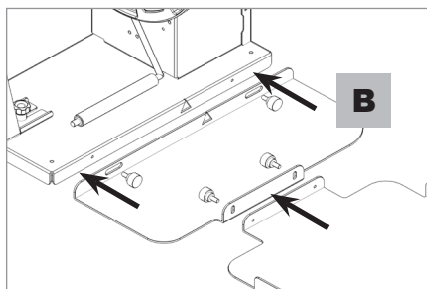

STEP 2

On the front side, place and screw the rewriter equipped with its own included plate (B).

Do not tighten the knobs until the rewriter will be properly aligned to the printer.

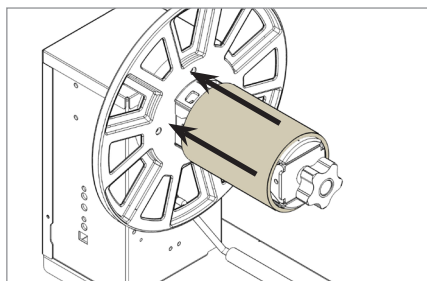

STEP 3

Load the empty cardboard core onto the core holder.

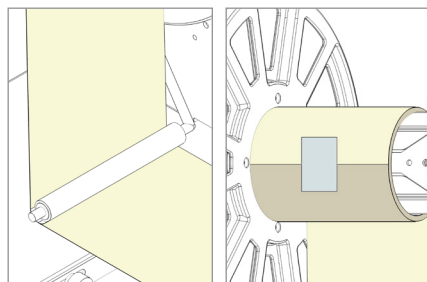

STEP 4

Keeping the printed media underneath the tension arm, stick the end on the cardboard core.

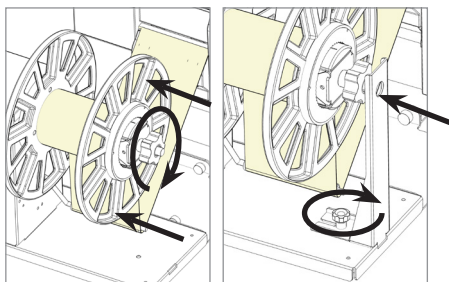

STEP 5

Slide in the outer disk onto the core holder and keep it close to the media edge.

Tighten the knob and install the additional support.

Once the media is loaded on the rewinder, slide left and right the rewinder to find the correct alignment between the two units and tighten the knobs.

FUNCTIONING

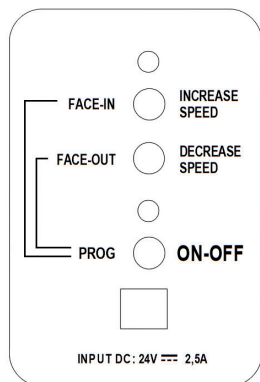

ON-OFF

Push this button to turn On or Off the unit.

INCREASE SPEED

Push this button to increase the rotation speed.

DECREASE SPEED

Push this button to decrease the rotation speed.

LABEL FACE-OUT

Turn the unit off. Keep pushed “FACE OUT” button, push and release “ON-OFF” button while the green led turns on and off. The unit is now ready to operate.

LABEL FACE-IN

Turn the unit off. Keep pushed “FACE IN” button, push and release “ON-OFF” button while the yellow led turns on and off. The unit is now ready to operate.

WORKING CONDITIONS

- When the printer forwards the media for printing, the tension arm goes down, the device rewinds the media. The green led is on.
- When the tension arm is in the middle position, the device is idle. Both yellow and green leds are on.
- When the printer backwards the media, the tension arm goes up, the device unwinds it. The yellow led is on.

When the unit is operating but the media is not loaded or it runs out, the tension arm reaches the lowest position and after few seconds the units will stop by itself, both leds blink and it beeps.

USER MANUAL

Label Unwinder
for EPSON C6500A



*Please keep the original packaging in case you need to return the unit.
If we receive the system in non-original packaging, the warranty may be void.*

The label unwinder specifically designed for Epson C6500A color label printer can handle rolls up to 220mm (8.66") media wide and having an outside diameter up to 250mm (10"). Unit is equipped with a fixed 3" core holder. An external power supply 100/240VAC - 2.5A $\overline{\text{---}}$ at 24V allows an electronic circuit to provide, through the tension arm, the speed and sense of rotation auto adjustment.

INSTALLATION

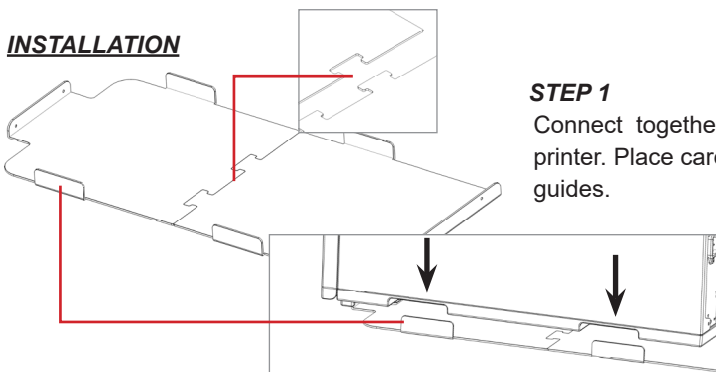

STEP 1

Connect together both plates and lean the printer. Place carefully the printer into the lock guides.

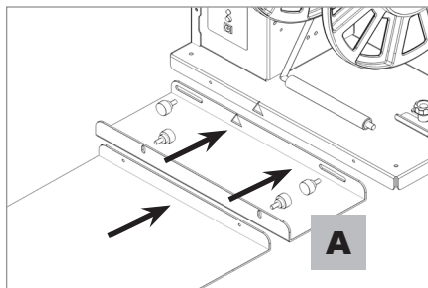

STEP 2

On the back side, place and screw the unwinder equipped with its own included plate (A).

Do not tighten the knobs until the unwinder will be properly aligned to the printer.

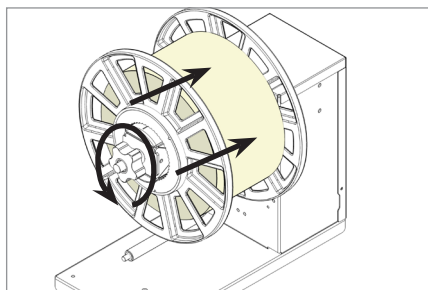

STEP 3

Load both roll of media and outer disk onto the core holder.

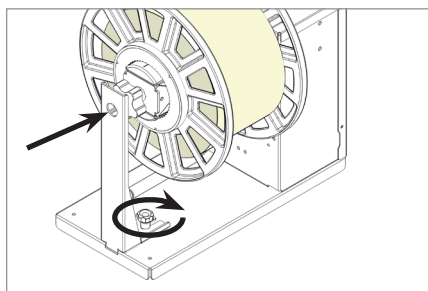

STEP 4

Tighten the core through the knob and install the additional support.

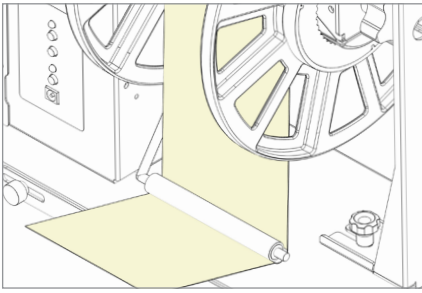

STEP 5

Keeping the media underneath the tension arm, turn on the unwinder and feed the media into the printer.

Please look at printer's user manual and follow the detailed procedure on how to load the media into the printer.

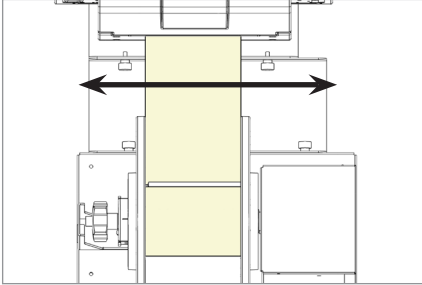

STEP 6

Once the media is loaded into the printer, slide left and right the unwinder to find the correct alignment between the two units and tighten the knobs.

FUNCTIONING

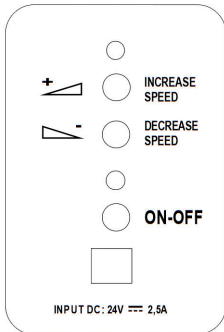

ON-OFF

Push this button to turn On or Off the unit.

INCREASE SPEED

Push this button to increase the rotation speed.

DECREASE SPEED

Push this button to decrease the rotation speed.

WORKING CONDITIONS

- When the printer forwards the media for printing, the tension arm goes up, the device unwinds the media. The green led is on.
- When the tension arm is in the middle position, the device is idle. Both yellow and green leds are on.
- When the printer backwards the media, the tension arm goes down, the device rewinds it. The yellow led is on.

When the unit is operating but the media is not loaded or it runs out, the tension arm reaches the lowest position and after few seconds the unit will stop by itself, both leds blink and it beeps.

SMART SOLUTIONS FOR THE LABELING INDUSTRY

Label rewinder, label unwinder, electronic label dispenser and more...

OTHER
PRODUCTS

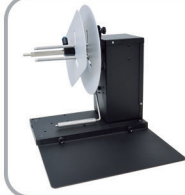

LABEL UNWINDER/REWINDER

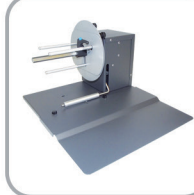

SMALL LABEL
UNWINDER/REWINDER



LABEL COUNTER



ROLL TO ROLL SYSTEM
FOR LABEL PRINTERS



ROLL TO ROLL SYSTEM
FOR EPSON PRINTERS

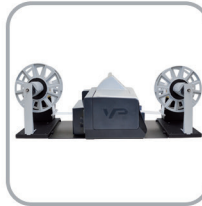

ROLL TO ROLL SYSTEM
FOR VIPCOLOR VP SERIES



ROLL TO ROLL SYSTEM
FOR PRIMERA LX SERIES



MATRIX REMOVER AND SLITTER

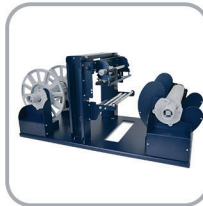

LONGITUDINAL LABEL SLITTER



EASY LABEL DISPENSER



ELECTRONIC
LABEL DISPENSER



SCORPIO SERIES:
DIGITAL LABEL FINISHING SYSTEMS



GEMINI:
DIGITAL DIE CUTTER FOR SHEETS



VIRGO:
DESKTOP DIGITAL FINISHING SYSTEM

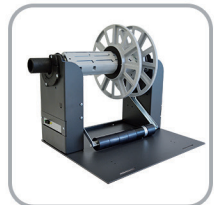

MOTORIZED CORE HOLDER
UNWINDER/REWINDER

- FOR MORE INFO CONTACT YOUR RESELLER -